

# Align-Pilates®



## **M8-Pro Reformer** Assembly Instructions & User Manual

Note: To check for the latest version of this manual please visit:  
<https://align-pilates.com/pilates-equipment-resources/assembly-user-guides/>  
For Patents & Patents Pending see [www.Align-Pilates.com/Patents-&-IP](http://www.Align-Pilates.com/Patents-&-IP)

# Introduction

Thank you for purchasing an M8-Pro reformer, which is crafted from solid North American maple, combining classical styling with contemporary functionality. Designed for studio, rehab or private use, this innovative design offers a host of easy adjustments to provide complete flexibility in use. This manual will show you how to assemble your M8-Pro reformer and then how to adjust it in use. Please ensure you read it fully before unpacking and assembling the equipment.

## Specification & Adjustability

- 104cm of smooth silent travel from the 8 PU wheel system
- Extra wide carriage for greater comfort and to suit more users
- 4 spring bar positions with Patent pending Rapid Change spring bar for the fastest spring bar changes
- Locking foot bar with 4 positions including completely flat
- Quick and safe simultaneous rope adjustment system
- Patented silent pulleys with silent design ropes & double loop handles
- Silent foot strap with fluffy
- 150kg maximum user weight

## Dimensions:

- Reformer only: 249cm x 76cm (at maximum dimensions)
- Weight: 80kg

**Please note the Assembly Instructions and User Guide for the M8-Pro may be updated from time-to-time. For the latest version of the manual, please visit: <https://align-pilates.com/pilates-equipment-resources/assembly-user-guides/>**

# Assembly

When using this manual if you are not sure which part the instructions are referring to please see the reformer map on page 7.

**Warning: the main box for the M8-Pro reformer weighs around 85kg so at least two strong people are required to unpack the equipment and correct lifting technique should be used. At all times you are responsible for your own safety and those around you.**

Please unpack the equipment in a clear, clean & dry environment on a level floor surface.



Fig.1

## Unpacking the main outer box:

- Carefully cut the bag using scissors & with one person at each end lift the reformer out.
- Remove the two accessory boxes and the bolt pack from the carriage box, see Fig.2, and move the large shipping carton out of the way (*we suggest you do not dispose of it until you are happy with the complete install*).
- Open Box 1 which contains the foot bar components. Remove all outer packaging from the components and discard the packaging.



Fig.2

d. On the reformer, cut the cable ties, which hold the chrome foot bar selector rod in place and remove the protective bag (Fig.3). *Note: Box 2 contains the standing platform which we will return to later.*

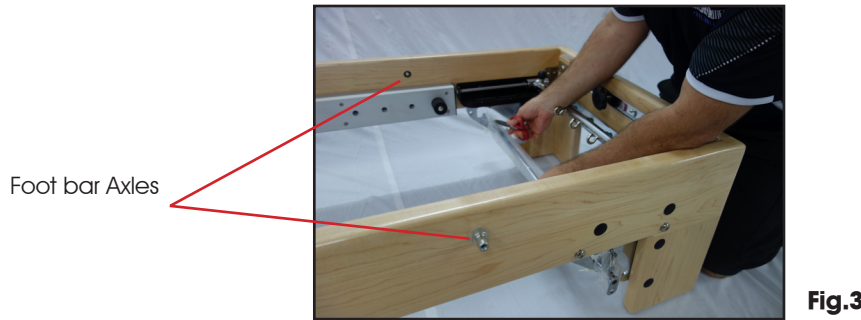

e. Place a nylon washer on the foot bar axle (Fig.3) then take one of the aluminium foot bar swing arms and place into position (Fig.4 & 5). Then, using an M8 12mm bolt with a single steel washer on the outside, use the allen key and socket spanner provided to tighten on the swing arm (Fig.6). Once on, use one of the black stopper plugs to close the hole where you inserted the socket spanner (Fig.7). Repeat on the other side.



**Fig.4**



**Fig.5**



**Fig.6**

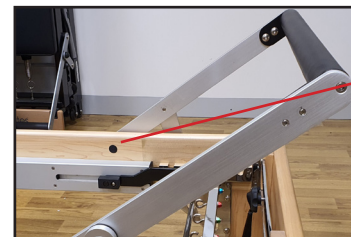

**Fig.7**

Black  
Blocker  
Plug

f. You are now ready to connect the chrome foot bar selector rod (Fig. 8) using an M8 x 20mm bolt and a dome headed M8 x 15 (no washers). Put the larger 20mm bolt part-way in first on the outside of both sides of the reformer, and then put the smaller bolt in from the inside and fully tighten, which will prevent the bar from rotating. Then, fully tighten the larger bolts on both sides.

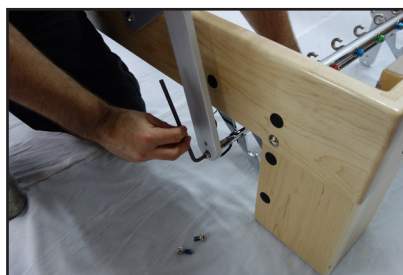

**Fig.8**

g. Now attach the padded foot bar. First insert the top larger bolts finger tight (M8 x 25mm), then insert the four M8 x 20mm dome headed bolts from inside (Fig.10). Then completely tighten all 6 bolts (Fig.11)



**Fig.10**



**Fig.11**

## 2. Unpacking the second outer box:

- Carefully take off the lid of the carriage bed box and remove the bubble wrap - do not use a knife as you may cut the vinyl - *(you will notice there is a second box, please remove and put aside for use later in assembly)* see Fig.12.
- We recommend 2 people remove the carriage bed from the box. It is best to familiarise yourself with the underneath of the carriage at this point, so you are familiar with the functionality, including the side wheel adjustment, spring attachment system and carriage anti-tipping device (Fig.13).



Fig.12

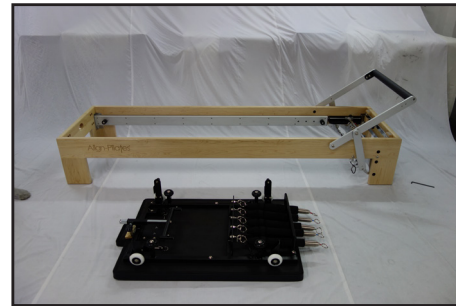

Fig.13

- You will need to insert the carriage bed (2 people required) at an angle so the anti-tipping system does not hit the runner *(please bear this in mind when removing the carriage in future - you can only lift up one side)*. You will also need to ensure the bed is correctly orientated with the springs towards the padded foot bar prior to inserting (Fig.14).



Fig.14

- It's now time to open the smaller box from the second carton, which contains the maple rope risers, the shoulder rests, pulleys, ropes, handles and bolts for the foot bar (Fig.15).

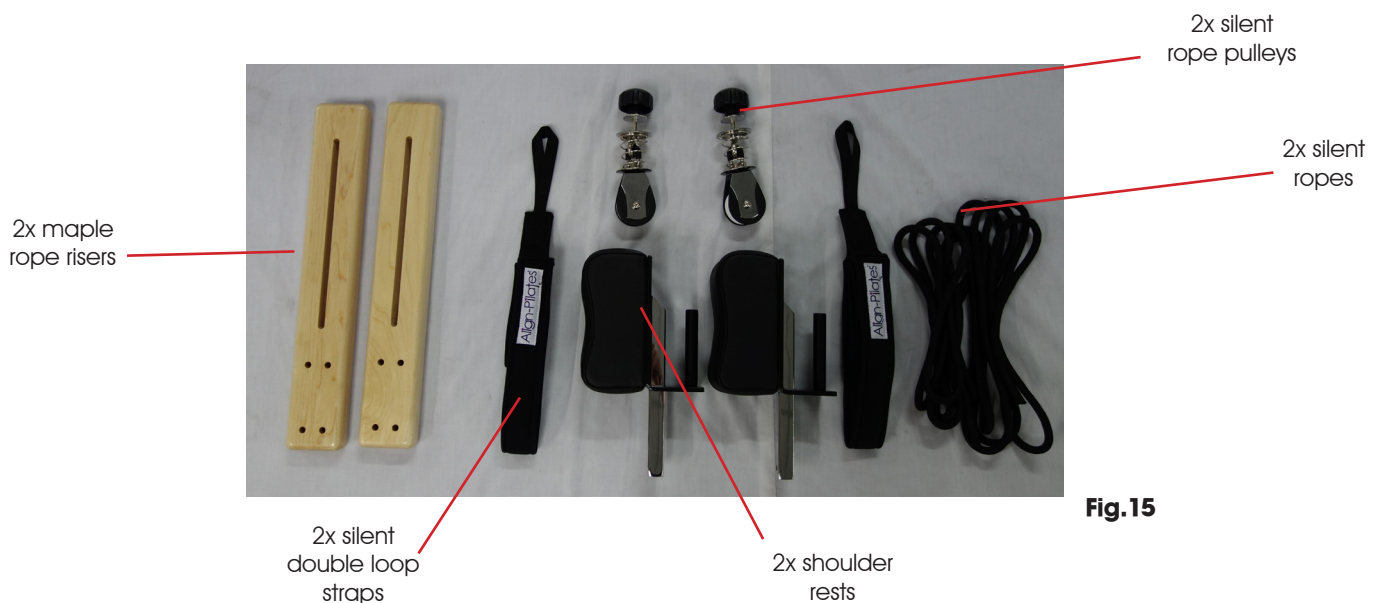
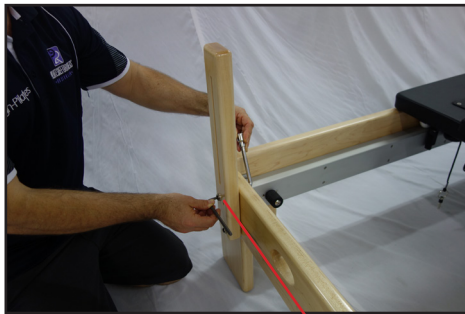

Fig.15

- e. Attach the maple rope risers using 8 of the M8 x 65mm bolts located in the bolt pack (from the carriage box). The bolts are inserted from the outside of the frame with the larger washer on the outside and small washer on the inside. Use the supplied socket spanner to hold the bolt as you tighten with the allen key. Do all the bolts up to hand tight, then go round and tighten them fully (Fig.16). Once tight, insert the black blocking plugs (Fig.17) and repeat for the second riser.



**Fig.16**

Washer

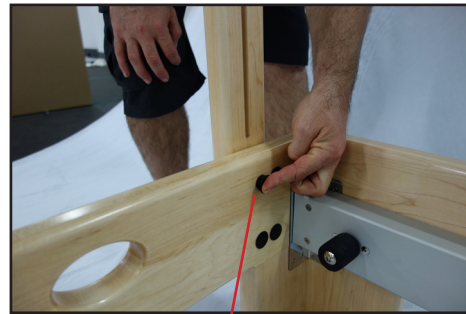

**Fig.17**

Black Blocker Plug

- f. You will now be able to attach the silent pulleys - there is a single washer which goes on the knob side of the pulley. We suggest during set-up to install the silent pulleys in the highest position, (Fig.18).

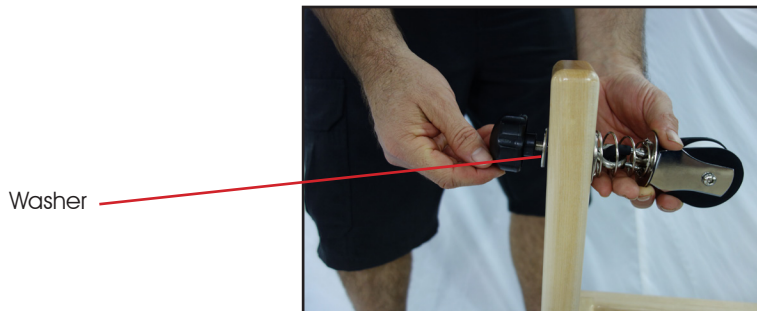

**Fig.18**

Washer

- g. Insert the shoulder rests and lock into place with the locking pin for additional security (Fig.19). Please note the

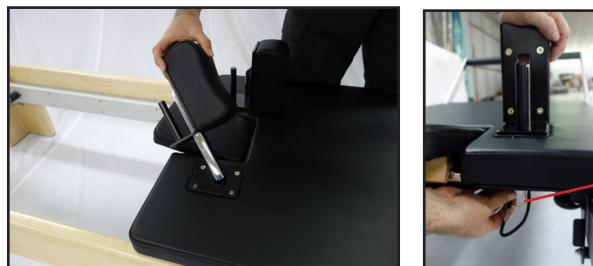

**Fig.19**

Locking pin

shoulder rests are asymmetric, so you can have a wider or a narrower setting for the shoulders, therefore be sure to insert them correctly.

- h. Now attach the handles to the rope by threading the loop through the rope eyelet and then threading the handle through the loop, see images from Fig.20 - 22.



**Fig.20**



**Fig.21**



**Fig.22**

Next, thread the end of the rope through the silent pulley from above and then slide the end through the T-Bar rope adjuster, under the carriage, you will need to pull down the locking handle to allow the rope end [to pass through (Fig.23).



**Fig.23**

### 3. Setting up the rope length

- First, put the spring bar as close to the foot bar as possible (attach at least one spring before moving).
- Now put the T-Bar in the position where the most of the chrome bar is revealed (this is the position where the ropes are longest) and put the larger foot handle over the shoulder rest as shown. (Fig.24).
- Next, pull the ropes through from underneath until they are both tight. When done tie a knot about six inches from the end of the rope (Fig.25) - the rope ends can be tidied away by wrapping them around the T bar.



**Fig.24**

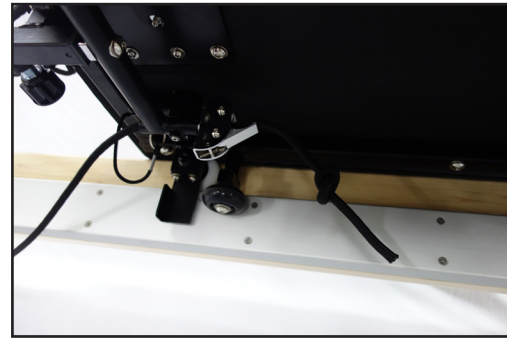
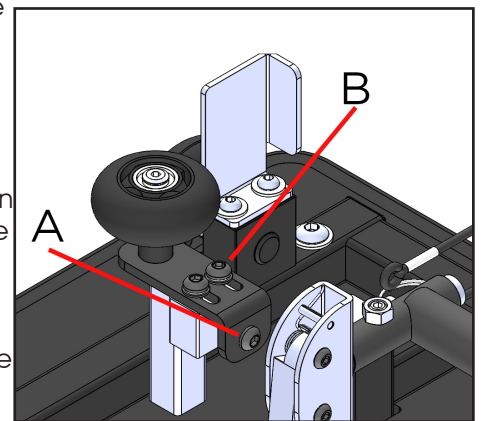

**Fig.25**

### 4. Adjusting the side wheels

After attaching at least one spring, roll the carriage back and forward checking that the carriage runs freely for the whole length of the runner. There should be no squeaking or interference from the side wheels, if there is the side wheels need to be moved inwards. Conversely there should not be excessive side to side movement of the carriage in the runners or the wheels need to be moved out.

To move the side wheels in (ie because they are causing the carriage to jam or, causing squeaking noises) unscrew bolt B a few turns (Fig. 26) then loosen the two A bolts and push the wheel bracket in until it hits the stop screw B, then retighten bolts A - now try the carriage again. If there is too much side to side movement of the carriage, then the side wheels need to be moved out. To do this loosen bolts A, then tighten bolt B by a few turns, which will push the wheel out, then retighten bolts A and try the carriage again. We recommend small adjustments each time and after a few tries you should get the carriage to run perfectly, with no interference from the side wheels & little side to side movement possible.



**Fig.26**

### 5. Attaching and adjusting the foot strap

- The foot strap attaches the same way the ropes attach to the handles. First separate the foot strap in to 2 parts
- Take each part of the foot strap and thread the loop through the eyelet beneath the spring bar, then thread the strap through the loop (Fig.27/28/29).
- When both sides are attached thread the end of the strap though the D rings (Fig.30).
- The strap can be shortened by pulling on the end of the strap, to loosen release the pressure by opening the D rings and then lengthening the strap.

Your M8-Pro Pilates reformer is now set-up and ready to use. Please read the User Guide information on pages 8-12 prior to first use.

# M8-Pro User Guide

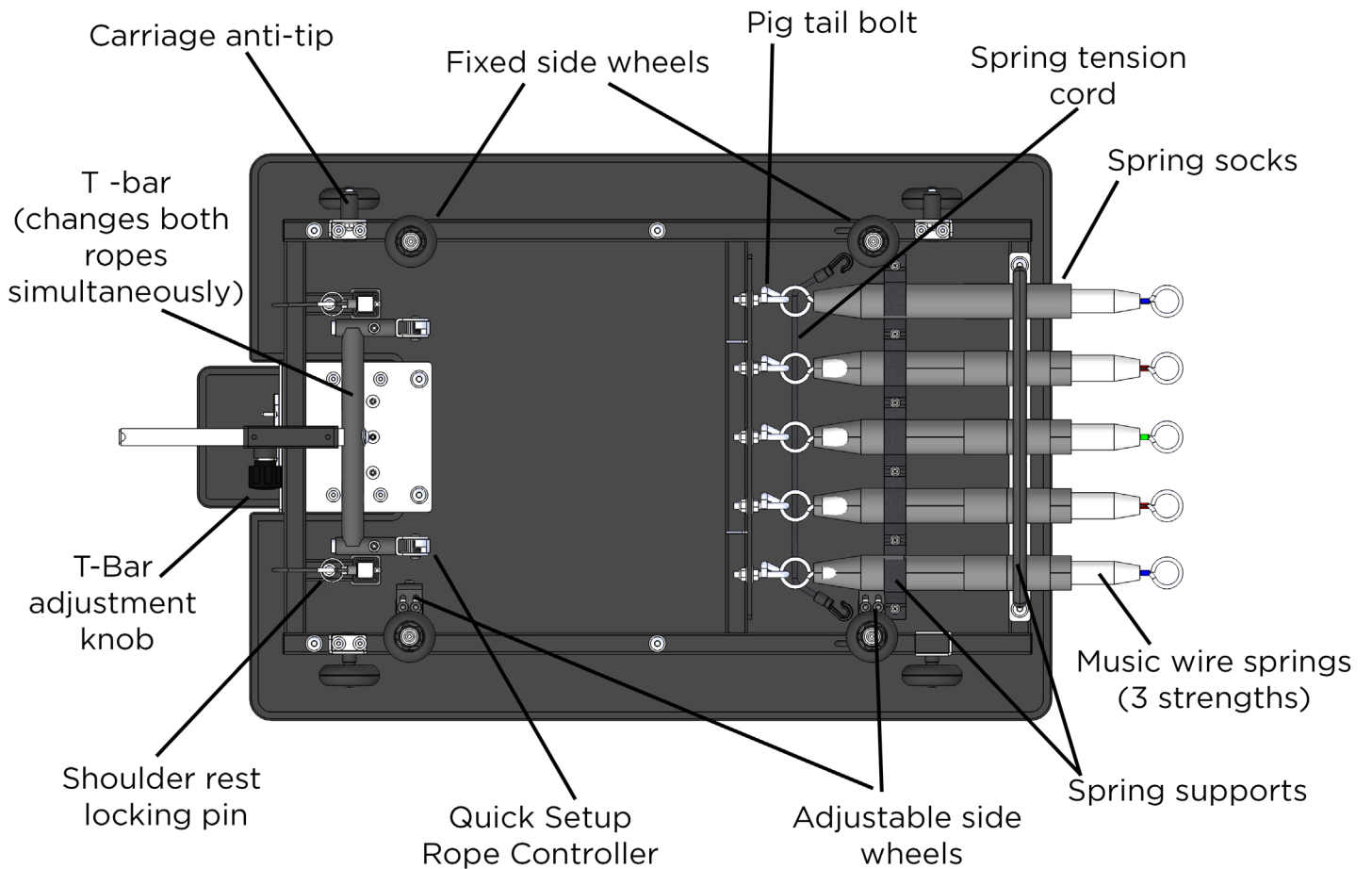
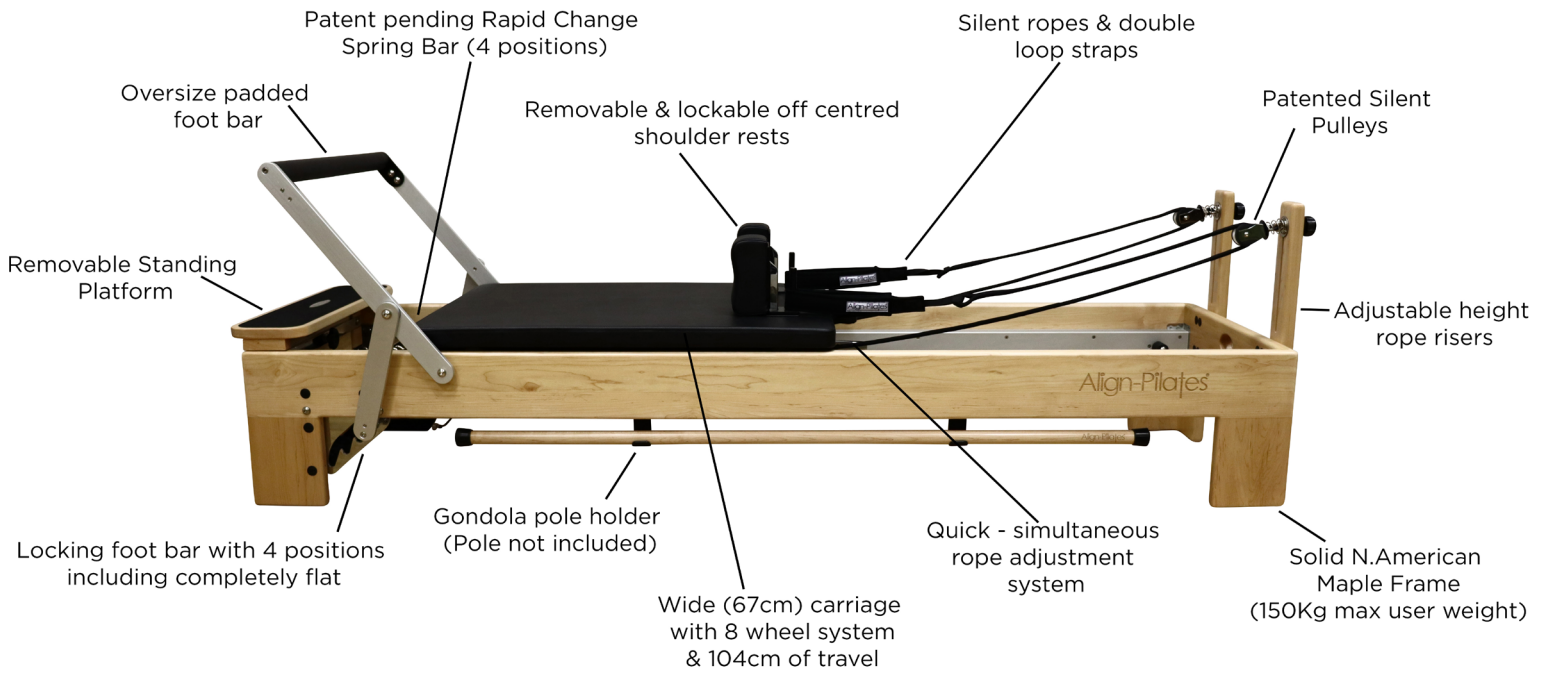

### 1) Identifying the springs

The springs can be identified with the corresponding colour code on the coloured nut:

- Red - Medium x 2
- Blue - Light x 2
- Green - Strong x 1



### 2) Adjusting the ropes

The M8-Pro includes the Pro Rope Adjusters which allows you to adjust the length of an individual rope for quick set up. Once set up correctly both ropes are adjusted together using the T bar - to move the T bar, loosen the twist pull knob and then pull out, so you can then slide the chrome part of the T bar in or out. As you move the spring bar away from the standing platform end of the reformer, slide the T bar in under the carriage to shorten the ropes. To lengthen the ropes pull the chrome end of the T bar out from under the carriage.

### 3) Adjusting the rope height

The ropes are very simple and easy to adjust; simply loosen the pulley knob and slide the riser to the desired height and tighten the knob back up to secure at the desired height.

### 4) Adjusting the spring bar with the Rapid Change spring bar

The new patent pending Rapid Change (RC) spring bar (Fig. 20) dramatically changes the speed and ease of moving your spring bar! Simply lift it up with the springs in place & move it to the desired new location - job done. Please note there is no longer a removable carriage stopper as there are integrated carriage stoppers on the side arms of the Spring bar. Adjusting the RC spring bar is up to 12 times faster than moving a traditional spring bar, which requires removal of springs, moving the stopper, moving the spring bar & reattaching the springs.



Important - The RC spring bar must always be moved with at least one spring attached. Visit the Align-Pilates YouTube channel for a video on adjusting the RC spring bar.

### 5) Adjusting the head rest

The head rest has 3 positions including flat. Use the wooden height adjuster block to select the height preferred.

### 6) Fitting the Standing platform

a. The standing platform, (which was originally packed within the main box) can be inserted either way round; first retract the locking knob, then insert the standing platform, and then tighten the knob. Always secure



Flat



Medium



High

the standing platform with the locking knob before use. Note: the standing platform can be used with or without the optional platform extender.

### 7) Fitting the optional Jump Board

a. The optional jump board is interchangeable with the standing platform

b. When using the jump board the foot bar must be in the third lowest position so the jump board is supported by the foot bar. Never use the jump board without it being supported by the padded foot bar. When inserted tighten the knob to hold the jump board safely in position.



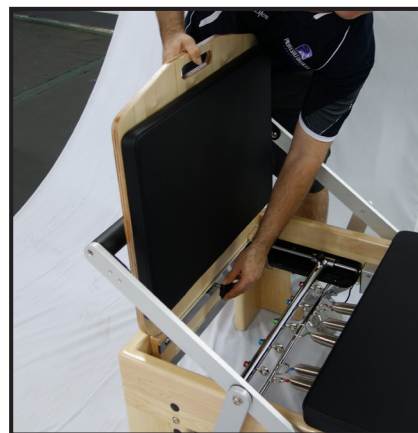
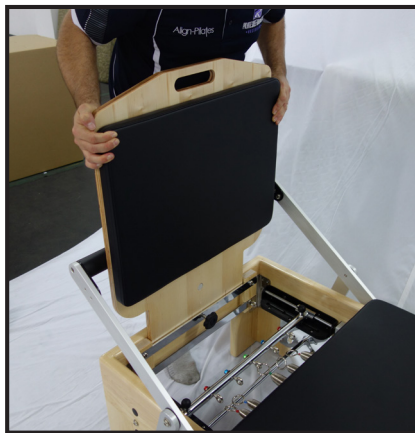
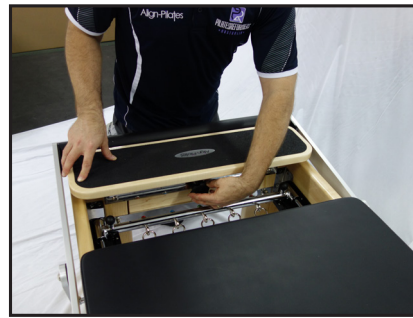
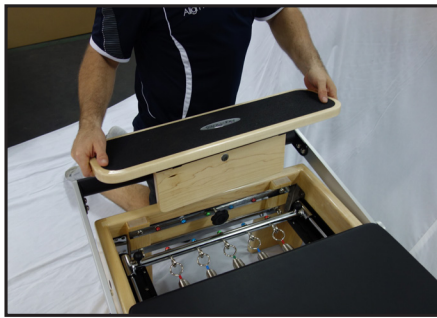

## Optional Extras

### Accessories for your M8-Pro Reformer

The M8-Pro Reformer has a complete range of optional accessories including: Half Cadillac with bracket, Mat Converter, Jump Board and Platform extender. All M8-Pro accessories are interchangeable with the preceding M2-Pro accessories

For the complete range of Align-Pilates apparatus & a complete range of Pilates mat work accessories please visit [www.Align-Pilates.com](http://www.Align-Pilates.com).



Mattress Converter & Platform Extender



Jump Board



Sitting Box (choice of two models)

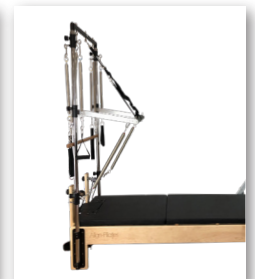

Half Cadillac



Gondola Poles & Maple Poles

## Exploded diagrams:

Note: For larger images of the exploded diagrams and a detailed parts list please download from: <https://align-pilates.com/pilates-equipment-resources/>

## ESSENTIAL SAFETY & MAINTENANCE INFORMATION (read before use)

### Periodic Maintenance

Please check the apparatus before first use and after each of the first few uses to check all the fittings are securely fastened. Thereafter, it is important to follow a regular maintenance schedule by someone familiar with the equipment and record your maintenance checks. Equally, inspection should be made immediately if any part appears not be operating correctly or something appears to be loose. Below follows a basic maintenance guide though our detailed maintenance guide and a sample maintenance log can be downloaded from <https://www.align-pilates.com/pilates-equipment-resources/assembly-user-guides/>

- Springs - Inspect for signs of wear, look for deformation, kinks, gaps and corrosion. Springs showing signs of damage must not be used and must be replaced immediately. Springs must be replaced every 2 years or after 3,000 hours, whichever is first, or immediately if showing signs of fatigue or deformation
- Foot bar - Check all allen bolts securing the padded bar to the aluminium arms and to the foot bar selector rod and through the frame are tight, but be careful not to over tighten.
- Runners - Ensure the runners are regularly cleaned and kept free from dirt as this is the main cause for a noisy reformer. If excess dirt is spotted on the runners then the wheels may also need cleaning. We recommend cleaning the runners with gym wipes by vital-clean.de, as recommended below for upholstery.
- Ropes and Handles - Check ropes for signs of wear, fraying or nicks and replace if damaged. Check stitching on handles and silent foot strap is intact and handles are not overly worn.
- PVC Upholstery - Always ensure belts, jewellery and shoes are removed when working on the equipment as buckles, rings, watches and bangles can all end up damaging the upholstery. For cleaning upholstery we recommend cleaning with gym wipes from vital-clean.de, which are available worldwide. For further information on cleaning recommendations see the link above.
- Wheels - Remove the carriage and check for smooth rotation, if the wheels are not turning smoothly or are scarred or damaged this will impede smooth and quiet running of the equipment and the wheels will need to be replaced. Check side wheels are adjusted correctly if squeaking is experienced - see page 6 for guidance.
- Shoulder Rests - Check the pads are securely bolted on to the metal frame - if loose retighten.
- Spring hooks - Hand check all eye hooks will not move. If loose remove, apply loctite and retighten. Check the spring retention bungee is correctly attached underneath the carriage.
- Nuts & Allen Bolts - Check all nuts and bolts are tight, including those on the rope pulley wheels and those securing the head rest and Half Cadillac if attached.

### Basic Reformer & Exercise Safety

If you are not familiar with using a Pilates reformer we suggest you seek advice from a qualified Pilates professional in order to learn how to get the most out of your reformer and to cover the basic safety aspects of using this type of equipment. A number of companies also offer short safety induction courses.

Pilates is about smooth and controlled movement, when performing exercises try to prevent the carriage from slamming in to the carriage stops and the springs from recoiling in an uncontrolled manner as this can damage the springs and shorten their life.

- Secure the carriage with at least one spring when your Reformer is not in use. Do not get on the carriage when there are no springs attached unless you deliberately want to do this.
- When standing on the reformer always put your first foot on the standing platform and then the other on the carriage. When getting off the reformer from standing take your foot off the carriage first and then step down off the standing platform.
- Use your reformer in a clear space with at least 1m of space all around the machine. This equipment is for indoor use only on a firm and flat surface.
- When using a reformer less is often more, remember when performing certain exercises less spring resistance makes the exercise more challenging.
- Before starting any exercise program, consult a physician.
- Before using the equipment, read and follow instructions in the safety manual and obtain thorough instruction from a Qualified Pilates Trainer.

- Use equipment only for recognised Pilates repertoire.
- Stop exercising if you experience chest pain, feel faint, have difficulty breathing or experience musculoskeletal discomfort.
- Keep clothing, body and hair free from all moving parts.
- Do not use if equipment appears worn, broken or damaged. Do not attempt to repair equipment yourself. Ensure equipment which is out of service cannot be used.
- Do not allow children to use or be around equipment without adult supervision.
- Do not exceed the maximum user weight for the equipment which is 150kg.

Congratulations! You are now ready to use your M8-Pro Reformer. Now would be a good time to make a note to replace your springs in 2 years or, within 3,000 hours of use, whichever is sooner. We hope you enjoy using your new M8-Pro reformer!

### **Troubleshooting Smooth Running of your M2 Pro Reformer**

If your reformer is not running smoothly and quietly please follow these steps in order to get it back up and running smoothly:

- Check the reformer is level using a spirit level
- Check the runners and wheels are clean and free from dirt and grit
- Check the side wheels are correctly adjusted and none of the wheels are damaged. If damaged, replace.

# Warranty Information

## **ALIGN-PILATES™ LIMITED LIFETIME WARRANTY**

### **Terms of Limited Lifetime Warranty**

Align-Pilates offers the following limited lifetime warranty, for the periods as stated below from the date of purchase, to the original owner of their products, upon presentation of an original invoice in their name. The warranty is a Light Commercial Warranty allowing for a maximum usage of 27.5 hours per week. Align-Pilates will repair or replace any mechanical part that malfunctions due to defects in materials and/or workmanship during the warranty period. The warranty excludes normal wear and tear, damage due to negligence or misuse, abuse, modification or unauthorized repair; scratches to the finish, and tears or indents in the upholstery. Align-Pilates will, at its discretion, repair or replace any parts deemed defective during the warranty period. If we opt to repair or replace your apparatus, this may require that your product is returned for inspection at our premises prior to sending out replacement apparatus. Parts repaired or replaced under the terms of this warranty will be warranted for the remainder of the original warranty period only. This warranty does not cover shipping charges, customs clearance fees (where applicable) or any costs incurred in installing repaired or replacement parts shipped under the provisions of this warranty. This warranty will be null & void if springs are not changed as specified or, if all safety, maintenance and usage instructions as specified in the manuals are not observed or, if the equipment is used for any other purpose other than for Pilates repertoire or if the equipment has been subjected to accident, abuse, improper service, or modification not authorised by Align-Pilates.

### **Duration of Limited Warranty**

#### **1) Metal Frames & welded components.**

10 year warranty

#### **2) Wooden Frames, Spring bar and foot bar mechanisms**

5 year warranty. Wooden frames must not be positioned next to convection radiators or air conditioning units.

#### **3) Other non-wear and tear components**

2 year warranty

#### **4) Ropes, Straps, Spring Clips, Silent pulley rubber shackle, Handles, Fuzzies, Wheels, foot straps, Rotational disks and Non Foam Rollers**

1 year warranty

#### **5) Springs**

2 year / 3,000 hours warranty is given on all springs, excepting that a decrease of 5% of the spring power per 1,500 hours usage is acceptable according to international standards. Align-Pilates Springs should be replaced after a maximum of 3,000 hours use or 2 years, whichever is earlier. In the event of any signs of damage or wear springs should be replaced immediately regardless of age or usage.

#### **6) Upholstery**

The upholstery fabric on Align-Pilates equipment will be replaced if it fails to give normal wear for 90 days from the date of delivery. Proof of damage may be required. This warranty does not cover cuts, scratches, burns, stains, soiling, or damages caused by unreasonable use such as wearing jewellery or inappropriate clothing whilst using the equipment. Align-Pilates reserves the right to substitute an equivalent fabric if an identical fabric is not available. Upholstery must be properly cared for as laid out in the manual.

### **Warranty Return Procedure**

The customer must call Align-Pilates or its authorized Distributor for authorization prior to returning the equipment. The customer is responsible for the cost of returning products to Align-Pilates (or their appointed Distributor) for warranty adjustment should this be deemed necessary. The customer is responsible for any damage or loss during shipment back to Align-Pilates (or their appointed Distributor). The customer is responsible for the cost of return freight to them in the event Align-Pilates decline to make a warranty adjustment. Align-Pilates do not accept responsibility for any items returned without a pre-approved authorization number, which must be clearly marked on the outside of the package.

### **Limitation of Liability**

The above is our exclusive warranty and is in lieu of all other warranties, express or implied, including warranties of merchantability or fitness for any purpose. In no event shall Align-Pilates or their Distributors be liable for incidental, consequential or punitive damages.

### **RETURNS**

Items that may not be returned:

Reformers, Cadillacs, Half Cadillacs, Wall units, Ladder barrels, chairs, mat convertors & springs.

### **CONTACT**

This warranty is issued by Align-Pilates Equipment Ltd. Contact details: 430 Enterprise Way, Vale Park, Evesham, Worcs WR11 1 AD, UK. Telephone + 44 1386 425920. Email: [customercare@align-pilates.com](mailto:customercare@align-pilates.com)

For more information about Align-Pilates equipment please visit: [www.align-pilates.com](http://www.align-pilates.com)